



TideMaster - Operating Manual



Document ID 0741822 | issue 2.1
Date: October 2025

This confidential document was prepared by the staff of Teledyne Valeport Limited, the Company, and is the property of the Company, which also owns the copyright therein. All rights conferred by the law of the copyright and by virtue of international copyright conventions are reserved to the Company. This document must not be copied, reprinted or reproduced in any material form, either wholly or in part, and the contents of this document, and any method or technique available there from, must not be disclosed to any other person whatsoever without the prior written consent of the Company.

© 2025 Teledyne Valeport Ltd

Teledyne Valeport Ltd
St Peter's Quay
Totnes TQ9 5EW
United Kingdom

Phone: +44 1803 869292
email: Valeport-Sales@Teledyne.com
Web: www.valeport.co.uk

As part of our policy of continuous development, we reserve the right to alter, without prior notice, all specifications, designs, prices and conditions of supply for all our equipment

Contents

1	Introduction.....	1
1.1	Description.....	1
1.2	Features.....	2
1.3	Mounting Template	3
1.4	Sensor Specifications	3
2	Installation	5
2.1	Equipment Supplied.....	5
2.2	Setting Up.....	5
2.2.1	TideMaster Logging Unit.....	5
2.2.2	Pressure Transducer	5
2.2.3	Shortening the Transducer Cable	6
2.3	Radar installations	6
2.3.1	Mounting.....	6
2.3.2	Levelling	7
2.3.2.1	Junction box	7
2.4	Calibration.....	8
2.4.1	Pressure Sensor.....	8
2.4.2	VEGAPULS C23 Radar Level Sensor.....	8
3	Powering the Unit	9
3.1	Battery Warning	9
3.2	To Turn the TideMaster On.....	9
3.2.1	Delayed Start.....	9
3.3	To Turn the TideMaster Off.....	9
3.4	Changing Batteries	10
3.5	Battery Life Scenarios.....	11
3.5.1	Scenario A.....	11
3.5.2	Scenario B.....	11
3.5.3	Scenario C.....	12
3.5.4	Scenario D.....	12
4	Running TideMaster Express.....	13
4.1	Installation.....	13
5	Communications.....	14
5.1	RS232 Communications	14
5.2	Bluetooth Communications	14
5.2.1	Specification	14
5.2.2	Pairing	16
6	Set Up	18
6.1	Interrupting TideMaster	18
6.2	Set Up TideMaster Using the Control Panel	18
6.2.1	Instrument Set Up.....	18
6.2.2	Sampling Set Up.....	20
6.2.3	Logging Set Up.....	20
6.2.4	Output Set Up.....	21

6.2.5	Reset option	21
6.3	Set Up TideMaster Using TideMaster Express	21
6.3.1	Communicate	22
6.3.2	Sampling Set Up.....	23
7	Calibration	26
7.1	Pressure Sensor	26
7.1.1	Pressure/Depth Relationship	26
7.1.2	User Calibration.....	27
7.1.3	Site Calibration	29
7.2	Radar Sensor.....	34
7.2.1	Working Range.....	34
7.3	Using TideMaster Control Panel	35
7.3.1	Pressure Sensor Calibration	35
7.3.2	Radar Sensor Calibration.....	35
8	Data Display in TideMaster Express	36
8.1	Real Time Data	36
8.1.1	File Period	36
8.1.2	Daily File Location	36
8.1.3	Backup File Location	36
8.1.4	Remote Data File Location	36
8.1.5	Open Prediction File	36
8.2	Data Download	37
8.3	Data Display - TideMaster Express.....	37
8.3.1	Simple Display	38
8.3.2	Scroll Display	38
8.3.3	Graph Display	39
8.3.4	Surge Graph Display	39
8.3.5	Last Data Display.....	40
8.3.6	Wind Rose Display	40
8.3.7	Prediction Files	40
8.3.8	Preset Displays & Display Handling	41
9	Data Requests and Output Formats	42
9.1	Stop Command	42
9.2	Run Commands.....	42
9.3	Logger Control	42
9.4	Data Formats	43
9.4.1	Logged Data (Pressure Tide & Met).....	43
9.4.2	Logged Data (Pressure Tide & CT).....	44
9.4.3	Logged Data (Radar Tide and Met).....	45
9.4.4	Logged data (Radar Tide and CT)	46
9.4.5	Real Time Data.....	47
10	Wiring Information	50
10.1	Tide (Pressure)	50
10.2	Tide (VRS-20 Radar) - Discontinued	50
10.3	WindSONIC	51
10.4	METPAK II	51

10.5 MaxiMet	51
10.6 miniCT	52
10.7 3m Y Lead (RS232)	52
11 Declaration of Conformity - TideMaster	53
11.1 UKCA Certificate	53
11.2 EU CE Certificate	54

1 Introduction

This manual covers the basic specifications, deployment and maintenance procedures for the following products:

- TideMaster
- Pressure transducer
- VEGAPULS C23 radar level sensor

This product has been designed to operate with Valeport's own TideMaster Express operating software.

1.1 Description

The TideMaster tide gauge has been designed to provide an accurate, versatile and easily deployed tide gauge for use in short or long-term hydrographic survey operations. It can be configured with either a traditional vented pressure sensor or radar sensor (VEGAPULS C23).

OLED control/display panel, Bluetooth and Secure Digital (SD) card memory combined with low power consumption and user selectable sampling regime allow up to a year's autonomous operation, whilst optional telemetry packages extend the capabilities for real time operations. The TideMaster is compatible with the MIDAS Surveyor GPS Echo Sounder system and a range of hydrographic processing software.

The logger is powered by 4 "C" type cells, which, together with the SD memory allows operation for over 1 year of sampling at a 15 minute cycle with 40 second bursts (pressure sensor system, with Display and Bluetooth disabled).

The TideMaster can be configured using either the optional Control/Display panel or using TideMaster Express (PC software package). Both allow the TideMaster to be configured, calibrated and the recorded data to be extracted and visualised.

The TideMaster can also run one additional sensor. The additional sensor will be run on the same sampling pattern as the tide sampling pattern. It can be specified with:

Gill Windsonic:	Wind Speed/Direction
Gill MetPak II:	Wind Speed/Direction, Air Pressure, Air Temperature, Humidity
Gill MaxiMet	Wind Speed/Direction (corrected), Air Pressure, Air Temperature, Humidity
Valeport MiniCT:	Water Temperature, Conductivity

A variety of telemetry options are available for remote access and delivery of data. Support for multi-gauge networks is supported in the TideMaster Express software.

1.2 Features

TideMaster shown below with optional OLED control display panel. Non-Display model is identical other than the absence of the display and the lower three control buttons.



Figure 1 – TideMaster features

1.3 Mounting Template

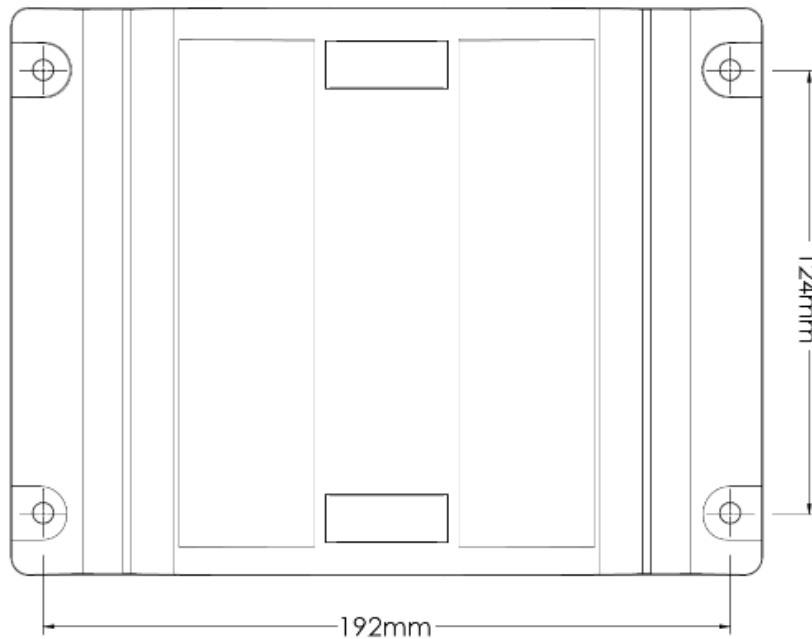

Figure 2 – TideMaster mounting template

1.4 Sensor Specifications

	Pressure Transducer	Radar Level Sensor
Type	Vented strain gauge, with stainless steel mounting bracket.	VEGAPULS C23 80 GHz W-band level sensor. Supplied with mounting bracket, junction box and 30 m cable as standard.
Range	Standard 10dBar (approx 10m), with 20m cable. Other pressure ranges and cable lengths are available.	Min: 0.1 m Max: 30 m
Beam angle	N/A	4°
Accuracy	±0.1% Full Scale.	±2 mm
Resolution	N/A	<2 mm
Calibration	Held within logging unit.	N/A
Dimensions	18mm diameter x 80mm.	76 mm diameter x 130 mm
Weight		~2 kg

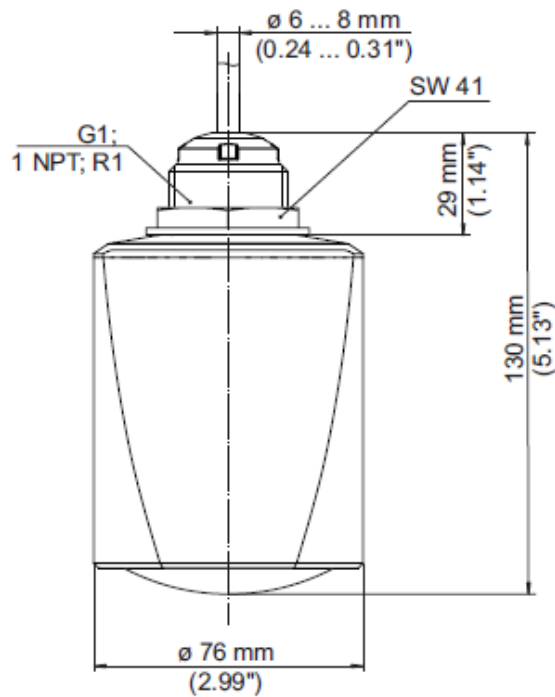

Figure 3 - VEGAPULS C23 dimensions

TideMaster - Logging Unit	
Housing:	Injection moulded housing, waterproof to IP67 (1m for 30 minutes) with injection moulded mounting bracket.
Display:	Optional 128x64 OLED keypad display for configuration and data display.
Internal Power:	4 "C" cells within separate sealed compartment.
	Tool-less battery change.
	Up to a year of autonomous sampling.
External Power:	9-28 V DC
Memory:	512 MB SD card memory allowing for effectively unlimited storage.
Sampling:	Raw data sampled at 8Hz and logged as average over burst.
	6 pre-programmed burst modes + custom sampling mode.
	Continuous Sampling at 1 Hz
Switching:	Power switch on unit. LED to indicate operation.
Resolution:	Data logged to 1mm resolution.
Comms:	Integral Bluetooth for short range telemetry and communications
	RS232/RS485 for cabled communication
Dimensions:	
Housing	47mm x 110mm x 197mm
Bracket	35mm x 210mm x 159mm
Mounted	62mm x 210mm x 197 mm
Weight:	1.1kg (approx) including batteries.

2 Installation

Ensure unit is not exposed to high heat levels due to sun strike etc. – user to provide an enclosure/method of shading to prevent extreme temperatures if required.

2.1 Equipment Supplied

The basic TideMaster system comprises the following:

- TideMaster Logger unit, with batteries
- TideMaster Mounting Bracket
- Data lead
- Windows software (TideMaster Express)

There is then an option of

- Pressure Transducer with 20m vented signal cable and mounting bracket
- or
- VEGAPULS C23 Radar Level Sensor with 30m of cable, junction box (Modbus – RS232 comms) and mounting bracket.

2.2 Setting Up

2.2.1 TideMaster Logging Unit

The TideMaster and mounting bracket must be mounted ABOVE the highest expected water line (HAT).

The unit is supplied with a mounting bracket and screws for the user to fix the unit to a convenient surface. A template for the mounting screws is supplied in Section 12.

The TideMaster is fixed to the wall bracket with the use of the supplied metal T-bar. The TideMaster should be placed in the bracket and the metal bar slid into place from the top. The bar can be locked in place with the use of the supplied screw. (NB. This can only be done before mounting the bracket to the wall)

For removal of the bar, it can be pushed up from the bottom of the housing until it can be reached at the top and removed. When removing the bar, care should be taken to support the TideMaster.

If the logger is installed, but not in use [i.e. cables not fitted] then ensure the connector covers are fitted to protect the pins.

2.2.2 Pressure Transducer

A mounting bracket is provided for the transducer. The transducer should be located below the lowest expected water level so that it does not dry out. For reference, the transducer pressure diaphragm (and therefore the pressure reference) is marked by the dark band on the transducer. A screw-on end cap protects the transducer. If this is removed for cleaning out of sediment, then care should be taken not to damage the diaphragm itself.

The transducer cable should be attached to convenient parts of the mounting structure with cable ties or clips (not supplied). Care should be taken not to squeeze or crush the cable so that the vented tube within the cable becomes closed.

The transducer cable should be connected to the connector on the TideMaster marked “TIDE”.

The transducer is provided with an integral 20m length of signal cable. Excess length can be coiled up, or the cable shortened.

2.2.3 Shortening the Transducer Cable

If a user wishes to shorten the signal cable, care has to be taken in re-terminating the connector in order to ensure the integral vent tube is properly terminated within the connector. If the cable is shortened, the pressure calibration will alter slightly, but provided the site calibration is carried out, any variations caused by the shortening of the cable will be taken account of. See Section 7.3 for Site calibration method.

2.3 Radar installations

Where possible, the radar must have a clear view of the water surface throughout the expected working range with no obstructions or fixed reflectors.

The VEGAPULS C23 is supplied pre-configured with a 30m maximum range. It is also supplied with a junction box for communications with the TideMaster (facilitating RS485 Modbus -> RS232 comms). The connections within the junction box are already made, and the junction box should be installed near/alongside the TideMaster. The radar is also supplied with mounting bracketry which allow the unit to be fixed to e.g. a length of scaffold. The instructions for mounting, described in sections 2.4.1 and 2.4.2 apply.

The table below shows the expected footprint of the VEGAPULS C23. Please note the figures are for the entire footprint as opposed to the footprint radius (presented in previous versions of this manual), using the formula:

$$(H \times \tan[\text{beam angle}]) * 2$$

Where H is the range value in meters, presented in the table below, and the beam angle is the value stated in Section 1.4.

VEGAPULS C23	
Range (m)	Footprint (m)
1	0.14
5	0.70
10	1.40
15	2.10
20	2.80
30	4.20

2.3.1 Mounting

The radar is supplied with a stainless-steel mounting bracket, plus two U-bolts, to allow for mounting to a boom/pole.

The bracket can be adjusted to allow for direct mounting to a flat, solid surface instead. In this instance, suitable screws/washers should be used instead of the supplied U-bolts. 8mm screws/washers should be used for this purpose.

2.3.2 Levelling

The radar antenna needs to be parallel to the water surface for reliable and consistent operation.

The radar should be levelled (ideally via geodetic survey) to a known datum. For reference, the radar antenna face is the datum point on this instrument, so please take this into consideration when installing. Further instrument dimensions are available in Figure 3.

Input the radar datum into the TideMaster, following the instructions in section 7.3.2. The TideMaster will then report a tide/water level value based on the datum of the radar.

2.3.2.1 Junction box

The VEGAPULS C23 is supplied with a junction box. This junction box contains an RS232-RS485 converter, which allows the radar to communicate with the TideMaster.

No intervention is required with the junction box – the cables are already fitted within and additional waterproofing applied to the cable glands.

Ensure that the junction box is mounted in the orientation shown below. Failure to do this may lead to water ingress, and invalidate the warranty.



2.4 Calibration

2.4.1 Pressure Sensor

If the TideMaster is supplied with a pressure sensor, it will be shipped with a factory calibration, which provides an output of pressure in decibars and takes out any non-linearity in the transducer characteristic. Note that the pressure calibration is specifically for a combination of TideMaster and transducer, and the unit and transducer serial numbers are held in the logger memory. If the transducer is changed, the pressure calibration will be slightly in error, but the system can still be used provided an in-situ calibration of depth against pressure output is made.

The user can add this calibration to provide output in metres [or feet] above a datum. This secondary calibration takes the form of a **Gain factor [distance per dBar]** and **Offset [transducer position with respect to datum]**. In order to determine this secondary calibration, some on site readings will need to be taken to establish the relationship between decibars and depth with respect to a datum for the particular site. The exact calibration is affected by **transducer offset, water density and gravity**.

The transducer is temperature compensated, but this compensation does rely on the temperature of all parts of the transducer being the same, so when the transducer is first put into water, time must be allowed for the temperature to stabilize before any calibration measurements are taken. Five minutes should be adequate.

2.4.2 VEGAPULS C23 Radar Level Sensor

The VEGAPULS C23 radar measures distance to a water surface and converts this into a water level or tidal height depending on the datum value held within the TideMaster.

It is important to ensure that the radar is installed above HAT, to ensure the unit always has a view of a water surface when taking its measurements.

The radar has a minimum range of 0.1 m (10 cm) and a maximum range of 30 m, providing a versatile solution for water level measurement in the majority of use cases.

3 Powering the Unit

3.1 Battery Warning



Batteries are prone to gassing and in the case of Alkaline batteries leaking potassium hydroxide, a caustic agent that can cause respiratory, eye, and skin irritations. You can reduce the risks by not mixing battery types in the same device and by replacing all the batteries at the same time and prior to full discharge.

Do not mix old and new batteries or battery types. Doing so will reduce overall performance and may cause battery leakage or rupture. We recommend replacing all the batteries at the same time.

3.2 To Turn the TideMaster On

The TideMaster switches on when the power button on the top right of the front panel is pressed (**quick press**). The LED to the left of the panel will flash ten times in rapid succession to indicate the unit is initialising.

The unit will then fall into its default sampling mode (or the last set mode). The start of a data collection burst is denoted by a single flash. The end of the burst is denoted by five flashes in quick succession. The burst modes sample at fixed intervals and so it may be some time before the first burst is collected. During this time the unit will be in sleep mode.

For example:

In B2 mode (6 min interval, 40 second burst) the TideMaster will collect data at:
00/06/12/18/24/30/36/42/48/54
minutes past the hour.

In B4 mode (15 min interval, 40 second burst) the TideMaster will collect data at
00/15/30/45
minutes past the hour.

3.2.1 Delayed Start

There is no delayed start mode and the TideMaster should only be powered on when ready to collect data.

3.3 To Turn the TideMaster Off

Press and hold the Power button until the LED light comes on. On the display version a powering off message will be displayed. When the LED light goes out, the TideMaster has powered off.

The TideMaster can only be turned off in sleep or sampling mode. If the TideMaster is interrupted either via PC control or via the integral display this mode will have to be exited before the TideMaster can be turned off.

3.4 Changing Batteries

Changing batteries in the TideMaster is very simple process.

All data is saved in non-volatile Flash memory, so data is secure during the battery change process.

The system clock requires battery power in order to maintain the current date and time settings, but the instrument is fitted with a capacitor system to maintain a supply to the clock for a period of not less than 20 minutes after the removal of the battery. This should be more than sufficient time to allow the battery to be changed.

In the event that clock settings are lost during battery change, or after an extended period of storage with no batteries fitted, then please use TideMaster Express or the control panel to reset the clock.

- Dry the top of the housing to ensure no water enters the battery compartment during the process.
- Undo the thumbscrews on the top of the housing. They are fitted with a retaining clip and cannot be completely removed.
- Gently slide the compartment lid up and out of the battery compartment. The lid is fitted with a retaining cord.
- Remove any residual moisture from around the seal.
- Replace the 4 C cell batteries, taking care to insert them in the correct orientation.

Take note of the orientation markings on the battery board. TideMaster will not operate if batteries are incorrectly installed.

- Check the O-ring on the battery compartment lid for damage and debris. Clean it and smear lightly with silicon grease.
- Replace the compartment lid and push gently into place. Tighten the thumbscrews – finger tight is sufficient.

This instrument left the factory with batteries fitted to enable you to use your instrument immediately. Please remove the batteries if instrument is being put into storage.

3.5 Battery Life Scenarios

The standard alkaline cells in the TideMaster have a nominal capacity of 6000mAh. Assuming 75% efficiency, this gives a usable life of 4500mAh. Use of lithium cells will extend these lifetimes.

In Burst mode, the unit cycles between 'Run' and 'Sleep' modes, making calculations complex. The tables below summarise the battery life of a scenario in each of the pre-set patterns.

Bluetooth connectivity is based on the Bluetooth being available for pairing. Pairing and sending/receiving data from the TideMaster draws more power and prevents the unit from entering sleep mode.

It is recommended that unless externally powered, Bluetooth connections are terminated when not required.

3.5.1 Scenario A

- Druck Pressure Transducer - Fitted
- Bluetooth Off
- Display Off
- Gill Windsonic – Not Fitted

Mode	Pattern	Battery Life
B1	30 seconds per 1 minute	56 days
B2	40 seconds per 6 minutes	231 days
B3	40 seconds per 10 minutes	356 days
B4	40 seconds per 15 minutes	487 days
B5	60 seconds per 30 minutes	598 days

3.5.2 Scenario B

- Druck Pressure Transducer - Fitted
- Bluetooth Off
- Display On Period – 5s
- Gill Windsonic – Not Fitted

Mode	Pattern	Battery Life
B1	30 seconds per 1 minute	57 days
B2	40 seconds per 6 minutes	231 days
B3	40 seconds per 10 minutes	356 days
B4	40 seconds per 15 minutes	488 days
B5	60 seconds per 30 minutes	598 days

3.5.3 Scenario C

- Druck Pressure Transducer – Fitted
- Bluetooth On – Every burst
- Display Period = 5s
- Gill Windsonic – Not Fitted

Mode	Pattern	Battery Life
B1	30 seconds per 1 minute	13 days
B2	40 seconds per 6 minutes	58 days
B3	40 seconds per 10 minutes	95 days
B4	40 seconds per 15 minutes	140 days
B5	60 seconds per 30 minutes	182 days

3.5.4 Scenario D

- Druck Pressure Transducer – Fitted
- Bluetooth On – Every burst
- Display Period = 5s
- Gill Windsonic – Fitted

Mode	Pattern	Battery Life
B1	30 seconds per 1 minute	4.7 days
B2	40 seconds per 6 minutes	20 days
B3	40 seconds per 10 minutes	34 days
B4	40 seconds per 15 minutes	51 days
B5	60 seconds per 30 minutes	67 days

All battery calculation figures are estimated, and may vary according to deployment temperature and the inherent battery variability.
Valeport accepts no liability for the failure of a battery to last for the expected lifetime.

4 Running TideMaster Express

TideMaster Express is Valeport developed software for use with the TideMaster tide gauge. It is designed for use in single gauge deployments as well supporting tide gauge networks.

The program allows the user to configure the instruments, view data in real time using a selection of displays, and extract and view logged data from logging instruments.

Additional Features of TideMaster Express:

- Support for up to 10 station tide gauge network.
- Support for multiple serial inputs (Cable, Bluetooth, GSM/GPRS, Radio)
- Support for UKHO prediction files (.mt04 format)

4.1 Installation

TideMaster Express has been designed for easy installation. It is compatible with Windows 10, Windows XP, Windows Vista and Windows 7/8. Open the install package and follow the on-screen instructions.

Once Installation is Complete, start TideMaster Express by double clicking on the desktop icon.

5 Communications

5.1 RS232 Communications

Communication with TideMaster is via the TideMaster Express software. The unit can also be interrogated by a terminal program such as HyperTerminal. Details of the commands that can be manually sent and received are provided in Section 9

The data cable supplied with the TideMaster is terminated with a 9-pin serial connector. If no serial port is available on the host PC then a USB-Serial adaptor is supplied with the unit.

Communication parameters are factory set to 115200 Baud, 8 data bits, 1 stop bit, no parity.

5.2 Bluetooth Communications

The TideMaster is also fitted with a Bluetooth communications chip. The system allows a wireless link to be established between an instrument and the operator's PC, performing exactly as if the instrument were connected to the PC via a serial cable.

Before Bluetooth communications can be established it is necessary to pair the TideMaster with the PC to be communicated with. A TideMaster can be paired with multiple PC's but can only be connected to one PC at a time.

Bluetooth communication will seriously deplete the battery lifetime.
It is recommended that unless mains powered, Bluetooth connections are disconnected when not required.

5.2.1 Specification

5.2.1.1 Product Description

For TideMaster built before 2023

The OBS418 and OBS419 are stand-alone Classic Bluetooth modules with UART logic level interface for fast, secure, and transparent serial data transmissions up to 150 meters. With the embedded Bluetooth stack, you can be up and running quickly as there is no need for a driver or stack in the host.

For TideMasters built after 2023

The NINA-B222 series are small, stand-alone dual-module Bluetooth modules designed for ease-of-use and integration in professional applications. The modules are delivered with u-blox connectivity software that provides support for both peripheral and central roles, Serial Port Profile, GATT client and server, beacons, u-blox Bluetooth low energy Serial Port Service – all configurable from a host using AT commands. The NINA-B2 modules provide top grade security, thanks to secure boot, which ensures the module only boots up with original u-blox software.

5.2.1.2 Approvals

The OBS419 modules are fully Bluetooth qualified and provide modular radio type approvals for the US, Europe, Japan and Canada:

- (FCC, R&TTE, MIC, IC).
- The modules are also compliant with EMC, Safety
The operating temperature range is –30°C to +85°C.

Section 5 | Communications

The NINA-B222 modules are fully Bluetooth qualified and provide modular radio type approvals for the US, Canada, Japan, Taiwan, South Korea, Australia/New Zealand, Brazil, South Africa.

- (FCC, IC/ISED RSS, MIC, NCC, KSS, ACMA, Anatel, ICASA)
- The modules will be qualified according to ISO 16750 for professional grade operation, supporting an extended temperature range of -40°C to +85°C.

5.2.1.3 Features

- OBS419: v2.1 + EDR (Classic Bluetooth)
- OBS419: 950 kbps
- NINA-B222: v4.2 + EDR (Bluetooth low energy 4.2 BLE dual-mode)
- NINA-B222: 1Mbit/s

5.2.2 Pairing

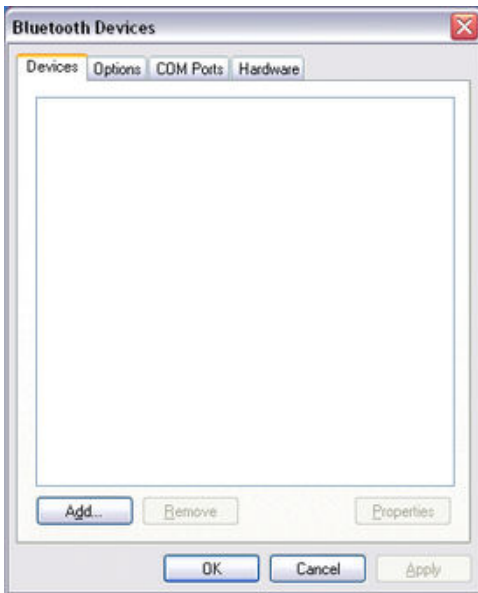

The following instructions are for pairing using standard Windows functionality. If you have a different Bluetooth set up or software then follow the instructions in the user manual for establishing an SPP connection (Serial Port Protocol)

Double Click the “Bluetooth Devices” icon on your PC task bar (bottom right) or access the Bluetooth Devices from the Control Panel

Click “Add” on the bottom left hand side of the screen

Using TideMaster control panel, Interrupt the TideMaster and Navigate to Bluetooth menu. Select pairing option (>Communications>Bluetooth>Pairing)

Using TideMaster Express, Connect with the TideMaster via cable (See Section 6.2.1). Select the Pair Bluetooth button in the lower left corner of the Communications Established window.

TideMaster will enter pairing mode for 60s.

Check the tick box and click Next.

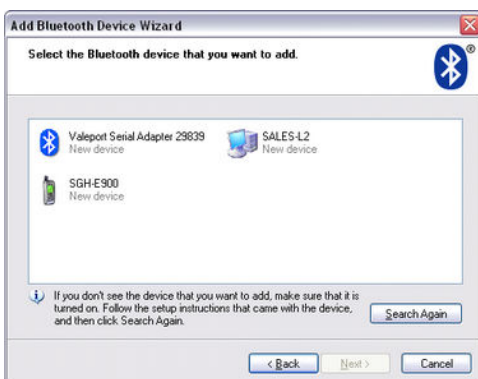

The PC will now scan for all Bluetooth devices in its range – this may include other PC’s and mobile phones as well as the Valeport TideMaster.

Highlight the Valeport TideMaster with the 5 digit serial number that matches your Bluetooth Transmitter (will be etched on the outside of the unit) and click next.

You will be asked for a security passkey which is 0 (zero).



At this point you will be assigned two COM port numbers, the important one is the outgoing COM port as you will need to select this port when connecting to the instrument.

Now your TideMaster is successfully paired you will be able to establish a serial connection using the assigned com port (Bluetooth baud rate is fixed at 57600).

6 Set Up

There are two main methods of configuring the TideMaster. If the instrument has a control/display panel it can be fully configured using this. Both the display and non-display TideMaster can also be configured using TideMaster Express.

6.1 Interrupting TideMaster

TideMaster can be interrupted immediately after power on and until the end of the first burst period. **The TideMaster cannot be interrupted during a sleep period** so it will be necessary to wait for the next burst period before the instrument can be interrupted.

If interruption is required without waiting for the next burst period, the unit can be powered down and powered up to allow interruption. See section 3 for detail of how to cycle the power.

6.2 Set Up TideMaster Using the Control Panel

This section shows the menu options available and the inputs required. Navigation through the menus is achieved using a combination of the four buttons on the front of the TideMaster.

Button Functions:

Power Button:	Turns unit on and off.
	On – single press, LED rapidly flashes ten times
	Off – Press and hold for ~5s, LED comes on and message displayed when unit is ready to power off
	Used for menu navigation
Left hand Button:	Interrupt unit and access menu when display is on
	Press and hold to show current display when unit is in sleep mode
	Used for menu Navigation and data entry
Central Button:	Used for menu Navigation and data entry
Right hand Button:	Advances display when display is on
	Press and Hold to advance display when unit is in sleep mode
	Used for menu Navigation and Data Entry

6.2.1 Instrument Set Up

This is where the TideMaster is configured, calibration parameters entered and output units defined. Attached sensors must be enabled, which then opens up the configuration menu for that sensor. See Section 7 for detailed instructions on how to perform site calibrations.

Section 6 | Set Up

Instrument

- Display
 - Change
 - Enter Value (005 default)
 - Off
 - Always On
- Press Tdr
 - Enabled
 - Cal Check
 - Vale Cal / User Cal values
 - User Cal
 - Datum Offset
 - > Enter Value
 - Gain Factor
 - > Enter Value
 - Site Cal
 - Enter Low Value
 - > Enter Low Tide Value / Take Pressure reading
 - Enter High Value
 - > Enter High Tide Value / Take Pressure reading
 - Calculate Cal
 - Output Units
 - dBar
 - Metres
 - Feet
 - Disabled
- Met Input
 - Enabled
 - Windsonic
 - Knots
 - mph
 - m/sec
 - MetPak II
 - Wind Speed
 - > Knots
 - > Mph
 - > m/sec
 - Air Pressure
 - > mBar
 - > hPa
 - Air Temperature
 - > Deg C
 - > Deg F
 - Disabled
- Radar Gauge
 - Enabled
 - Calibration
 - Datum Offset
 - Max limit
 - Min limit
 - Output Units
 - Metres
 - Feet
 - Disabled

The MiniCT sensor cannot currently be enabled via the on screen menus. The instrument must be interrupted (See section 9) and the following commands used to enable/disable. A miniCT set up menu will be available once the sensor is enabled.

#075 Reads back current miniCT status (0 – disabled, 1 – Enabled)

#074;0 Disables miniCT sensor

#074;1 Enables miniCT sensor

6.2.2 Sampling Set Up

The sampling set up of the instrument can be configured in this menu. Default burst modes can be selected or a custom sampling mode can be user defined.

- Sampling
 - Burst
 - B1 - 30s/1 min
 - B2 - 40s/6 min
 - B3 - 40s/10min
 - B4 - 40s/15min
 - B5 - 60s/30min
 - Continuous
 - M1 - 1Hz
 - Custom
 - Burst Interval Mins
 - Enter Value
 - Burst Duration Secs
 - Enter Value

6.2.3 Logging Set Up

Date/Time can be configured in this menu, and any existing data files erased from the unit.

- Logging
 - Set Time/Date
 - DD/MM/YYYY HH:MM:SS
 - Clear Memory
 - Yes
 - No

6.2.4 Output Set Up

Output setting can be configured within this menu. Data format is set to TideMaster NMEA as standard. All files will be internally logged in the same format regardless of the chosen real time output format.

If Bluetooth is not required then it should be disabled in this power. Pair with Device is used to authorise Bluetooth communications with a PC. See section 5 for further details.

Telemetry ID allows a station ID from 1-10 to be set and a transmit delay to be configured for radio telemetry.

- Output
 - Data Format
 - TideMaster NMEA
 - Valeport 740
 - Tide 710
 - Met 710
 - LED 710
 - RS232 Setup
 - 9600
 - 19200
 - 38400
 - 57600
 - 115200
 - Bluetooth Setup
 - Enable Bluetooth
 - Disable Bluetooth
 - Pair with Device (Code = 0)
 - Telemetry Setup
 - Set Station ID
 - Set Delay

6.2.5 Reset option

The reset option is used for a soft reset of the TideMaster. This should be used when uploading a new firmware. Contact Valeport support for detail of how this is carried out.

Reset

6.3 Set Up TideMaster Using TideMaster Express



When you click "Comms Wizard", on the menu bar, this screen will appear:

There are 3 buttons available, the function of each is described on screen and below.

The Communicate button allows you to talk to the instrument for the purposes of setting it up or extracting recorded data files to PC.

The About button displays the current version number of the software. Valeport support staff may ask you for this number if you have a technical problem.

Exit closes down the TideMaster Express program.

6.3.1 Communicate

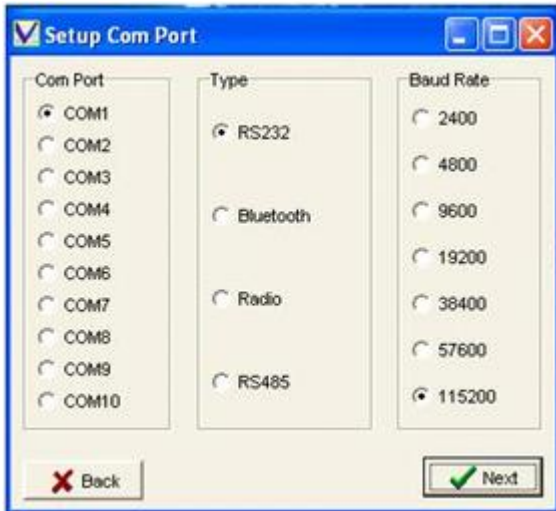

Click the Communicate button on the Welcome screen to begin the process of connecting to the instrument. This screen will be shown:

The comm port box on the left will list all the comm ports fitted to your PC. Choose the port that you wish to use to communicate with the instrument.

The Type box in the centre of the screen lists the available communications options:

RS232	This standard format is always available, and allows communications direct with PC. Use the standard 3m Y lead between instrument and PC for this method. The vast majority of applications will use this method - unless you have a specific adapter for one of the other modes, use RS232
Bluetooth	Valeport offers a Bluetooth communications adapter allowing wireless communications with the PC. Defaults to 57600 baud.
Radio	Valeport offer a Radio Telemetry Module allowing medium range wireless communications between a PC and TideMaster. See Radio Telemetry manual (0741808a) for details of how to configure.
RS485	Allows communications over long cable lengths (up to 1000m). It requires a special adapter and additionally you must set the instrument to operate in this mode. The procedure for this is to FIRST use the Y lead only to connect the instrument to the PC. Select RS485 in the Type box, and click Next. The software will communicate with the instrument, and will then set it to RS485 mode. When communications have been established, simply connect the RS485 adapter to the Y lead for the RS485 adapter. Defaults to 38400 baud.

Baud Rate is the speed at which the PC and the instrument communicate. TideMaster always leaves the factory set to 115200.

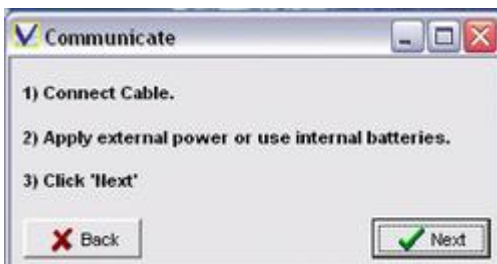

When you have chosen the correct Comm Port, Type and Baud Rate, click Next. The following screen will appear.

Follow the instructions, and Click Next.

Section 6 | Set Up

Having established communications, you are presented the current instrument status on the left and with 6 options on the right:

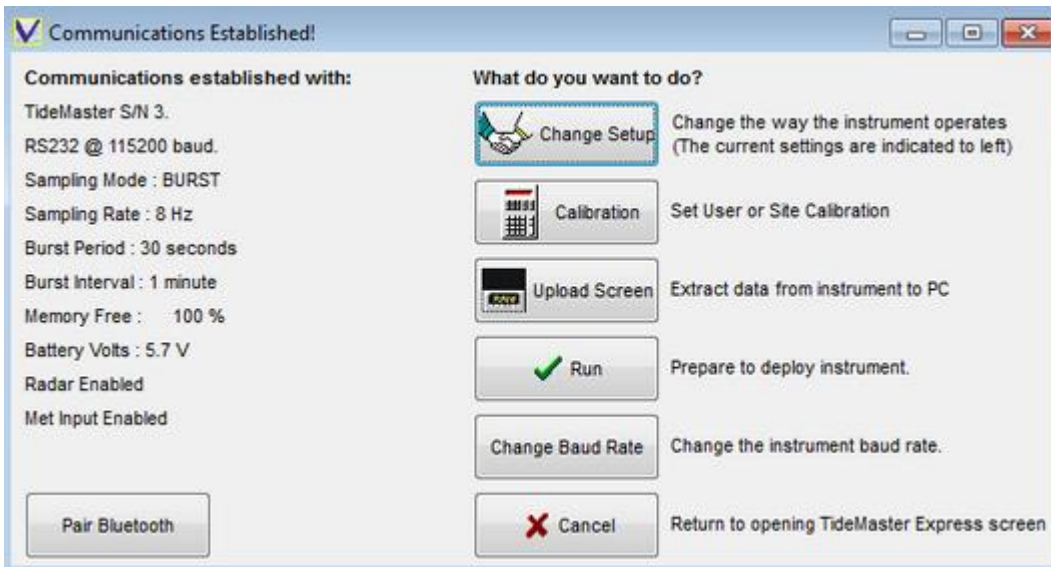

Change Setup	Click this button to change the way that the instrument samples data, and to adjust basic parameters such as the date and time. If you are not sure how the device has been set up, you should use this function to check it before deployment.
Calibration	Allows a user or site calibration to be carried out.
Upload Screen	If you have just deployed the device and wish to recover the data it has logged, use the Upload Screen button. This also allows you to erase the memory.
Run	This button will set the device into Run mode using the current settings. It will begin to log and output data according to the sampling scenario you have set.
Change Baud Rate	Having established communications at a particular baud rate, you may wish to change this to suit your particular requirements. For example, a higher baud rate may be suitable for extracting large amounts of data, or a lower rate for using longer cable lengths.
Cancel	This button will close communications and return you to the opening screen.

6.3.2 Sampling Set Up

TideMaster is intended to be operated with burst type sampling. In burst modes the data will be collected for a fixed period, e.g. 40 seconds, the data will be averaged and then the TideMaster will return to a sleep mode for a defined interval, e.g. 6 minutes, until the next burst.

The TideMaster can also be operated in a continuous mode. If fitted with a pressure sensor, a reading will be recorded every two seconds. No averaging is applied to the reading. If fitted with a radar sensor, a reading will be output every ten seconds. This reading is an average of 5s of samples.

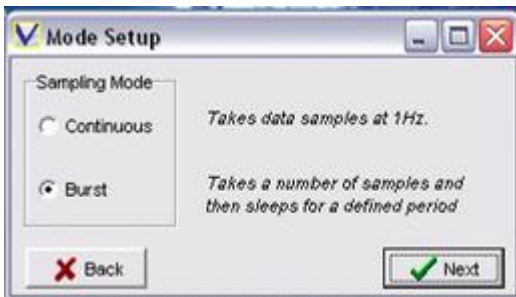

Battery lifetime requirements are critical to the choice of sampling pattern and further consideration to projected battery lifetimes are given in [section 3.4](#)



The TideMaster has a number of predefined sampling patterns and the option for a user defined sampling pattern.



The TideMaster has a very accurate real-time clock. This can be synchronised to the PC clock at set up.

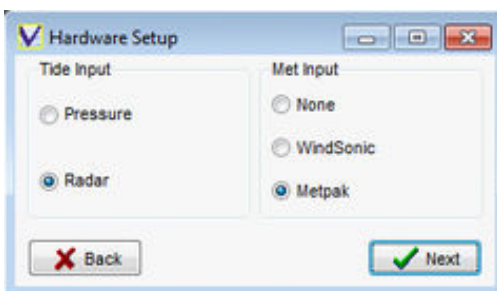

The fitted sensors can be enabled/disabled

Output units for the tide sensor and optional met sensors can be defined as metric or imperial and the window will differ depending on radar or pressure being fitted.

Section 6 | Set Up

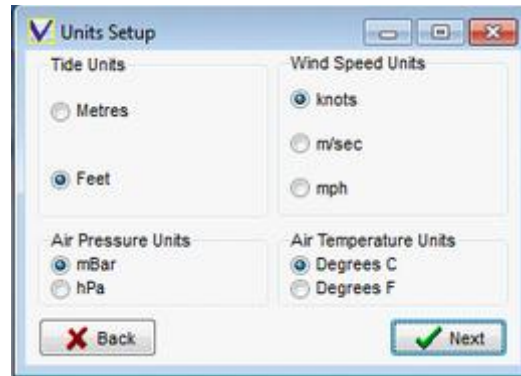
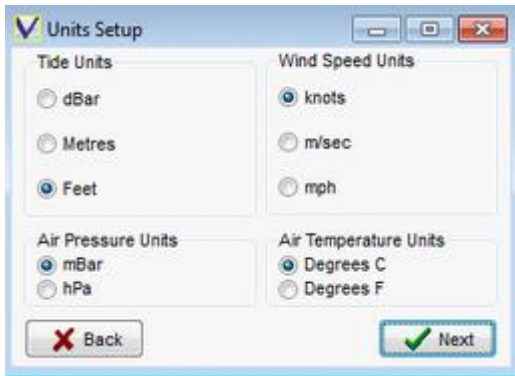

Data is both logged and output in the selected format. For a pressure sensor the conversion from pressure to depth will be based on the calibration factors stored in the TideMaster. This is not required for a radar sensor.



A site name or details can be entered into the site info box. This is a free text field.

For use in multi-gauge networks, a station ID can be assigned to the TideMaster. This can be from 1-10

Display period defines the number of seconds the display will come on for at the end of a burst.

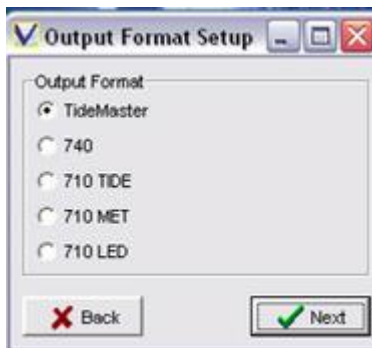

Real time output can be transmitted in a number of formats. The choice of format does not affect the logged data which is always stored in the same format.

TideMaster format is the default choice although a number of options have been added to ensure compatibility with existing networks and equipment



All TideMasters are fitted with Bluetooth for short range serial communications. If not required then this should be disabled as it uses up valuable battery capacity. To retain Bluetooth and save power it is possible to reduce the number of bursts the Bluetooth is made available for.

Radio telemetry can be added to the system and a variable transmission delay in seconds can be defined to avoid conflicts.

7 Calibration

7.1 Pressure Sensor

When supplied with a pressure sensor, the TideMaster is supplied with a factory calibration, which provides an output of pressure in decibars and takes out any non-linearity in the transducer characteristic. Note that the pressure calibration is specifically for a combination of TideMaster and transducer, and the unit and transducer serial numbers are held in the logger memory. If the transducer is changed, the pressure calibration will be slightly in error, but the system can still be used provided an in-situ calibration of depth against pressure output is made.

The user can add to this calibration to provide output in metres [or feet] above datum. This secondary calibration takes the form of a **Gain factor [distance per dBar]** and **Offset [transducer position with respect to datum]**. In order to determine this secondary calibration, some on site measurements will need to be taken to establish the relationship between decibars and depth with respect to a datum for the particular site. The exact calibration is effected by transducer offset, water density and gravity.

The transducer is temperature compensated, but this compensation does rely on the temperature of all parts of the transducer being the same, so when the transducer is first put into water, time must be allowed for the temperature to stabilize before any calibration measurements are taken. Five minutes should be adequate.

7.1.1 Pressure/Depth Relationship

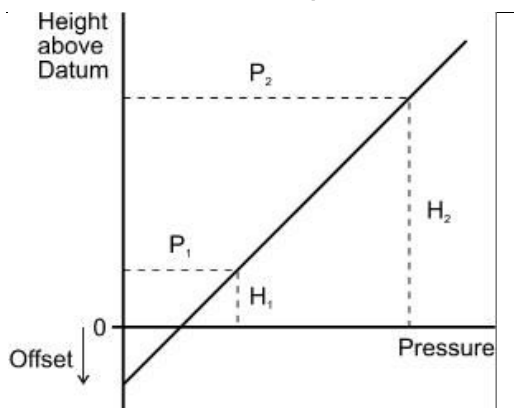

The relationship between pressure and depth in shallow water is a straight-line function:

$$\text{Height above datum} = (\text{Gain} \times \text{Pressure}) + \text{Offset}$$

Where Offset = Transducer position with respect to a Datum [+ve if above datum, -ve below].

e.g. if the transducer is 1.15 metres below datum, then the offset is -1.15 metres.

$$\text{Gain} = (H_2 - H_1) / (P_2 - P_1)$$

$$\text{Offset} = H_1 - (P_1 * (H_2 - H_1) / (P_2 - P_1))$$

7.1.2 User Calibration

If USER calibration method is set, the unit will set itself to output data calibrated according to user input Gain Factor and Datum Offset.

The relationship between depth and pressure for shallow water can also be expressed as:

$$\text{Depth} = \frac{\text{Pressure}}{\text{Density} \times \text{Acceleration due to Gravity}} + \text{Offset}$$

Where:

Pressure is measured in Pascals (1Bar = 105 Pascal, therefore 1 dBar = 104 Pascal)
and, (Density * Acceleration due to Gravity)-1 is the Gain Factor

7.1.2.1 Gain Factor

Fresh Water

Using a standard density of 994 kg/m³ [pure water at 15°C] and a gravity figure of 9.81m/s²

$$\text{Depth (m)} = \frac{104}{994 \times 9.81}$$

then 1 decibar = 1.025 metres water depth

Therefore, Gain Factor = 1.025

Sea Water

Using a standard density of 1025.97 kg/m³ [standard seawater at 15°C] and a gravity figure of 9.81m/s²,

$$\text{Depth (m)} = \frac{104}{1025.97 \times 9.81}$$

then 1 decibar = 0.993 metres water depth

Therefore, Gain Factor = 0.993

If the user knows the density of the water (by using a hydrometer) and the local gravity value, the Gain Factor can be calculated.

7.1.2.2 Offset

If the Transducer is below the Datum, the Offset should be entered as a negative value. If the transducer is above the Datum, the Offset should be entered as a positive value.

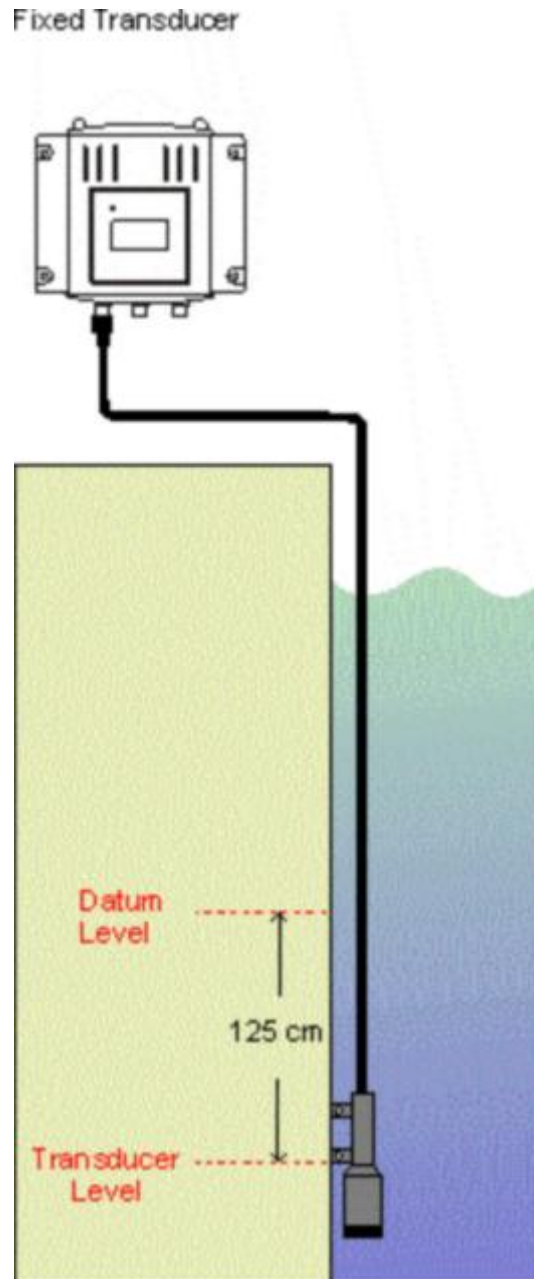

To check the operation of the unit with these user input values, select cal check to view data from the transducer in both pressure (dBar) and Depth (m/ft) formats.

In practice, however, it is much preferred to carry out a calibration of the transducer in-situ to take out the density and gravity variations and establish the datum, as described in [Section 7.3](#).

7.1.3 Site Calibration

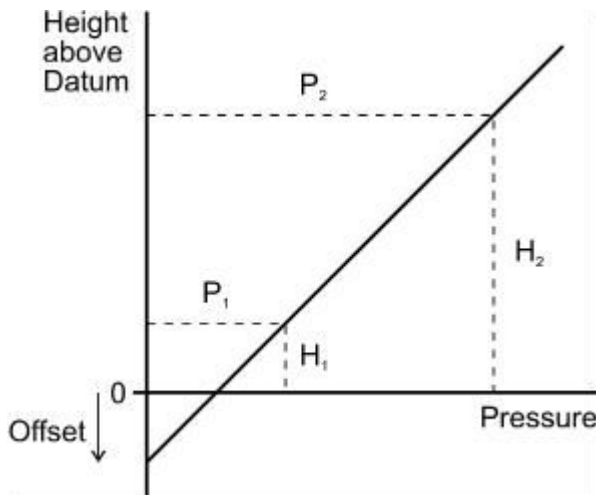

The aim of a site calibration is to derive a suitable gain and offset value by measuring the relationship between pressure and tide at the top and bottom of the tidal range.

Measuring this relationship at two points on the tidal curve will allow the gain and offset to be derived. This is done automatically in the instrument using the following formulas:

$$\text{Gain} = (H_2 - H_1) / (P_2 - P_1)$$

$$\text{Offset} = H_1 - (P_1 * (H_2 - H_1) / (P_2 - P_1))$$

To ensure the best possible fit, it is recommended the two points are measured at the extremes of tidal range i.e. high tide and low tide. If waiting for a tidal cycle is impractical then it is possible to mimic a tidal cycle by raising the transducer by a known amount. This is described below as the moving transducer method.

Site Calibrations can be carried out using either of two methods:

- Fixed Transducer Method
- Moving Transducer Method

The factor determining whether a fixed or moving transducer calibration should be performed is determined by how the transducer is mounted.

The fixed transducer method, as its name suggests, is used when the mounting of the transducer is static and thus cannot be raised or lowered. Two readings are taken, one at low tide and one at high tide, and the gain and offset calculated.

The moving transducer method can be used when the transducer is mounted on the Valeport slide wiring kit (or similar construction) thus allowing the unit to be raised and lowered in the water column to simulate the change in water level of the rising or ebbing tide.

7.1.3.1 Fixed Transducer Method

SITE CALIBRATION METHOD - Fixed Transducer

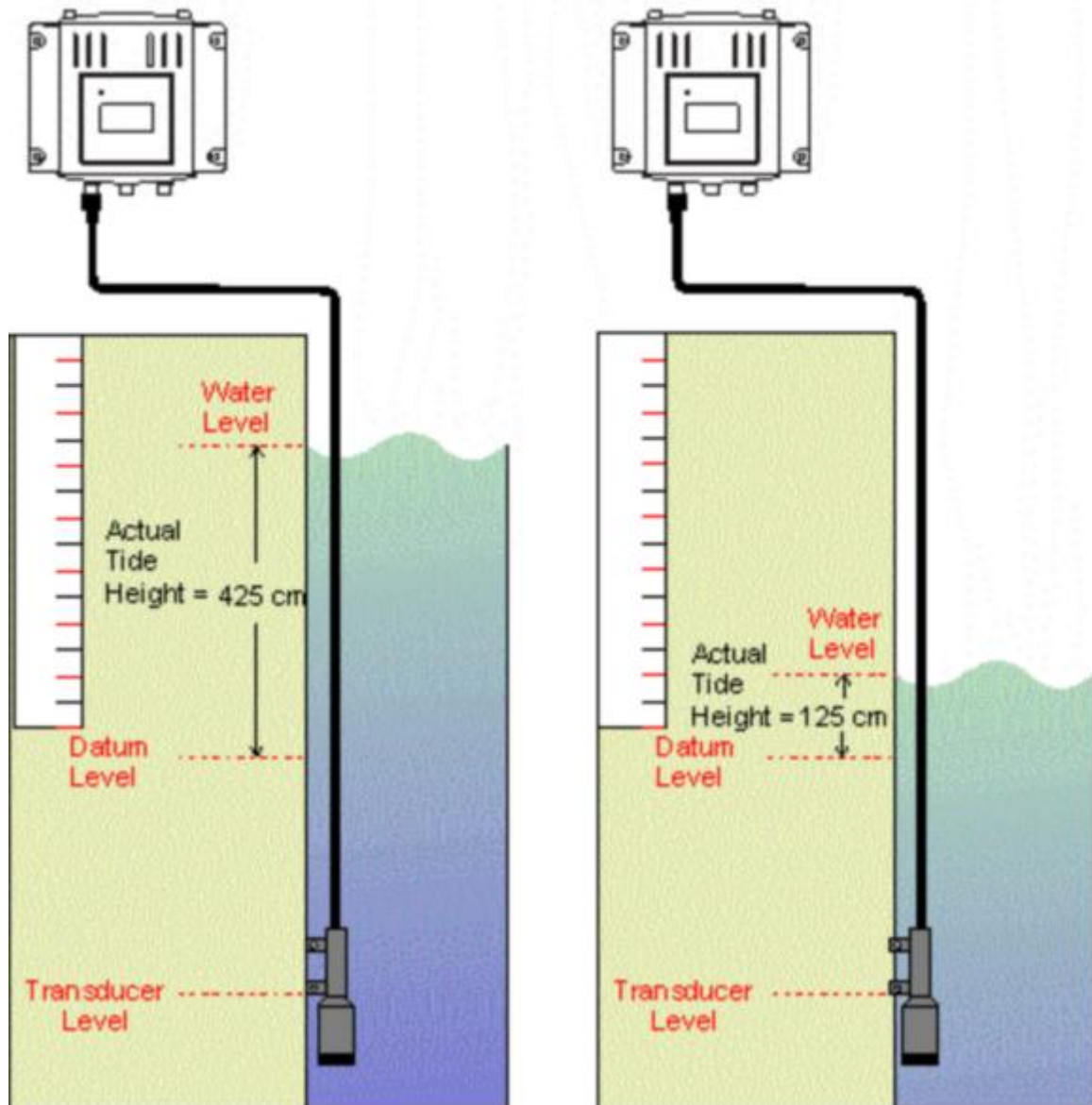

Install and fix the transducer in the desired position, and connect it to the TideMaster

Run the TideMaster Express program on the PC.

Connect the TideMaster to the PC, having previously selected the correct comms port, and select Connect to "break in". See [section 5](#) for help.

Section 7 | Calibration

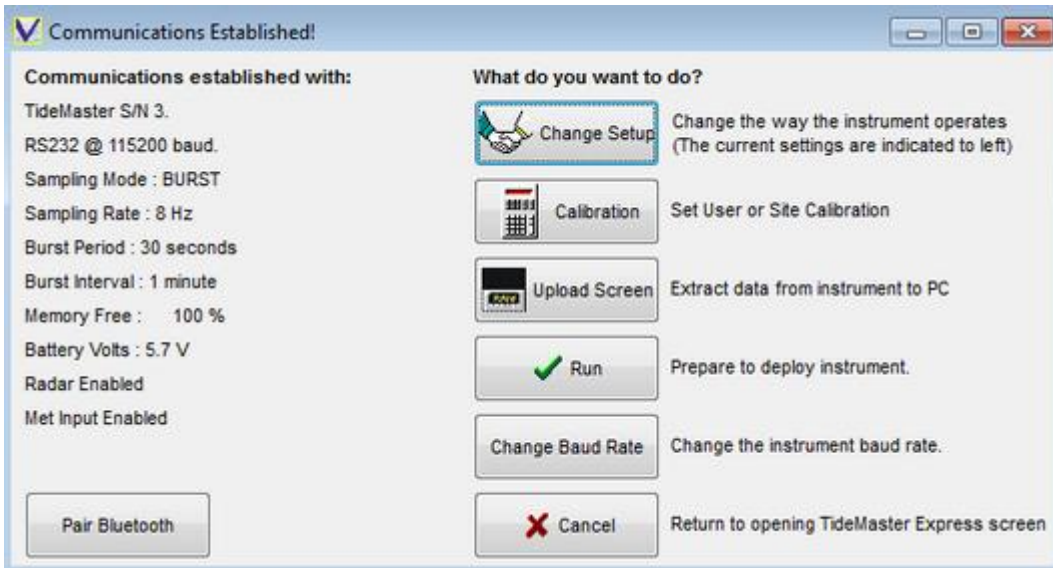

At the communications established screen select the Calibration option.



Select Site Calibration and required output units



Low Calibration:

At the **lowest expected tide**, Enter the Low Tide Height, either read from a calibrated Tide Board or staffing gauge **relative to a known datum**.

Press the **Get Reading** button – TideMaster will sample pressure readings for 30s and record the Low height/pressure relationship.

High Calibration:

At the **highest expected tide**, Enter the High Tide Height, either read from calibrated Tide Board or staffing gauge **relative to a known datum**.

Press the Get Reading button – TideMaster will sample pressure readings for 30s and record the high height/pressure relationship.

The high and low readings can be collected in either order, and repeated if necessary. It is possible to disconnect from the TideMaster and return later to carry out the second part of the calibration.

Once you are happy with the collected pressure/height readings the **Generate** button will calculate the calibration factors and update the Gain and Offset parameters.

Clicking **Next** will then apply the calibration coefficients to the TideMaster and run a cal check. This will display raw data in dBar, and calibrated data in Metres and Feet. The calibrated data should correspond to the current tide height relative to your datum.

7.1.3.2 Moving Transducer Method

This is essentially the same as the Fixed Transducer Method, but does not require a waiting period between level measurements:

SITE CALIBRATION METHOD - Slide Wire

Transducer attached to slide wire. Position relative to Datum unknown
Water Density unknown.
Tide Height Known

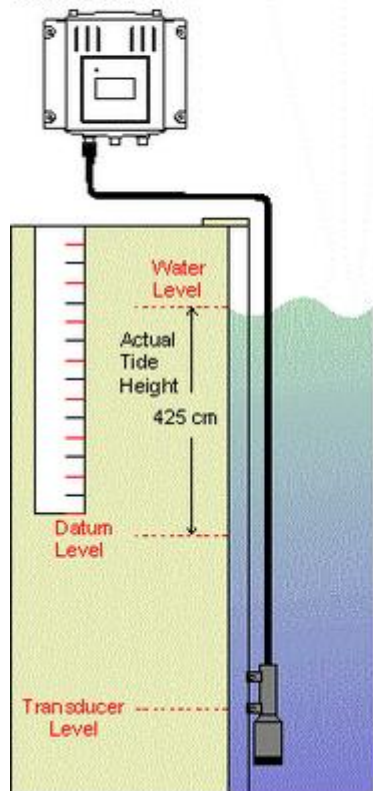

Raise the transducer a known distance (400cm in this example).

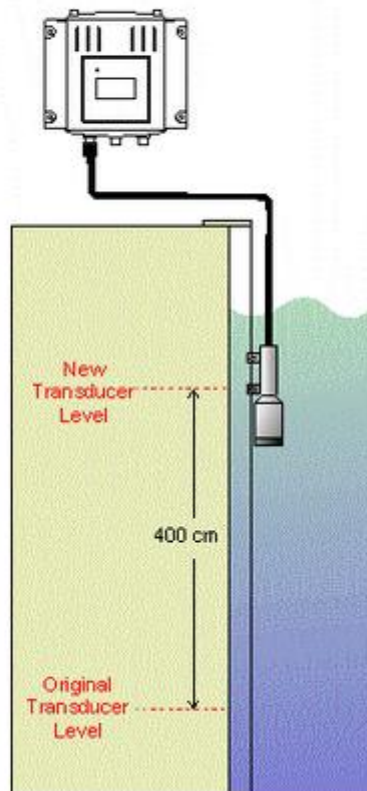

Lower transducer back to original position

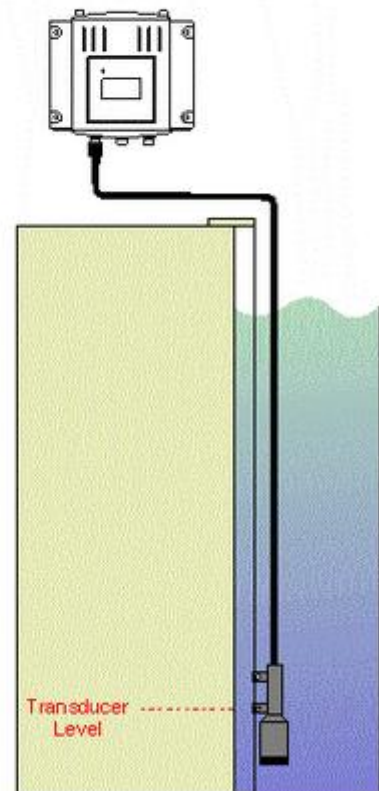

High Calibration:

Enter the **High Tide Height**, either read from a calibrated Tide Board or staffing gauge relative to a known datum.

At the highest expected tide, Enter the High Tide Height, either read from calibrated Tide Board or staffing gauge relative to a known datum.

Press the **Get Reading** button – TideMaster will sample pressure readings for 30s and record the high height/pressure relationship.

Move the transducer up by a **known distance**, i.e. 400cm

Low Calibration:

Enter the Low Height value (subtract the **moved distance** from the **Measured High Tide Height** and input into Low Tide Measurement)

Press the Get Reading button – TideMaster will sample pressure readings for 30s and record the Low height/pressure relationship

Once you are happy with the collected pressure/height readings the Generate button will calculate the calibration factors and update the Gain and Offset parameters.

Return the Transducer to its **original position**.

Clicking **Next** will then apply the calibration coefficients to the TideMaster and run a cal check. This will display raw data in dBar, and calibrated data in Metres and Feet. The calibrated data should correspond to the current tide height relative to your datum.

Clicking Next will apply the calibration coefficients to the TideMaster and run a cal check. This will display raw data in dBar, and calibrated data in Metres and Feet. The calibrated data should correspond to the current tide height relative to your datum.

7.2 Radar Sensor

The VEGAPULS C23 radar sensor measures distance to a water surface. To transform this range to a tidal height, the offset between the Radar Datum and a Local Datum must be established.

7.2.1 Working Range

The C23 has an incredibly low minimum range, being able to measure the water surface from as little as 0.1m away (in some conditions, lower than this). The maximum range is 30 m. The sensor datum can be set within the TideMaster (see Section 7.3.2), and this will be used to convert the values into a tidal height which is the output from the TideMaster.

7.3 Using TideMaster Control Panel

Calibrating the TideMaster using the display panel is essentially the same process as described above.

7.3.1 Pressure Sensor Calibration

Interrupt the TideMaster on start up or during a burst using the left hand menu button.

Navigate to the Pressure Transducer Site Calibration menu
(Menu > Instrument > Press Tdr > Site Cal)

There are three options available.

- Enter Low Value
- Enter High Value
- Calculate Calibration

Use these menu options to follow either the moving or fixed transducer method entering Low/High values using the appropriate menu option when prompted. When you are happy with the values entered, use the Calculate Calibration option calculate the calibration factors and update the Gain and Offset parameters.

Run a Cal check. (Menu > Instrument > Press Tdr > Cal Check)

This will display raw data in dBar, and calibrated data in Metres and Feet. The calibrated data should correspond to the current tide height relative to your datum.

7.3.2 Radar Sensor Calibration

Interrupt the TideMaster on start-up or during a burst using the left hand menu button.

Navigate to the Radar Calibration menu
(Menu > Instrument > Radar > Calibration)

There are three options available:

- Datum Offset
- Max Limit
- Min Limit

8 Data Display in TideMaster Express

Data can be obtained from the TideMaster in real time or by downloading logged data files from the instrument. At the end of burst period data is logged internally and transmitted out of the instrument via a serial connection. If optional telemetry is connected to the TideMaster then this data may be received and displayed at a remote location using TideMaster Express.

Both logged data and real time data can be visualised using the basic graphing capabilities of TideMaster Express (see section 8.3) or for further analysis, data can be easily imported into Excel, Matlab or similar.

8.1 Real Time Data

Data is transmitted from the TideMaster at the end of every burst period. Data will be transmitted in the selected output format. TideMaster Express will monitor its last used serial port and log any data received on that port. This data will be logged and backed up.

The File menu provides access to configuration of file periods and locations.

8.1.1 File Period

The logged data that TideMaster Express used for real-time displays can be stored as a continuous file which will keep logging data as long as the program is open or daily/weekly/monthly files

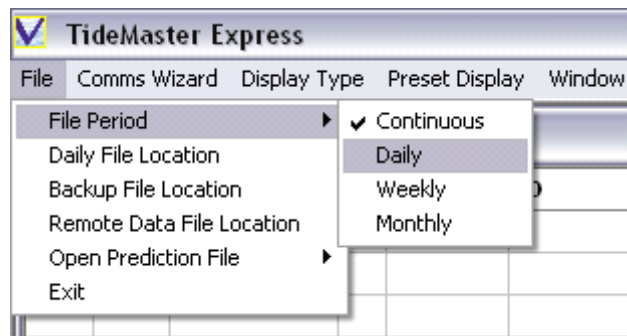

8.1.2 Daily File Location

Defines where the logged data is stored. Can be stored on a local drive or attached network drive. Data is stored in a separate file for each parameter received.

8.1.3 Backup File Location

Data can be backed up to a second location. Can be stored on a local drive or attached network drive. Data is stored in same format as logged internally on the TideMaster unit.

8.1.4 Remote Data File Location

A remote user running TideMaster Express can display data from the daily files stored on a shared network drive.

8.1.5 Open Prediction File

Loads a tidal prediction file as defined in section [Prediction Files](#)

8.2 Data Download

To Upload data from the instrument memory, it is first necessary to establish communications as described in Section 6.2. From the “Communications Established” window, click the “Upload Screen” button.

This screen lists all the data files held in the instrument’s memory. It also shows the size of the file, and the date and time at which it was created. Note that a new file is created each time the instrument is put into “Run” mode,

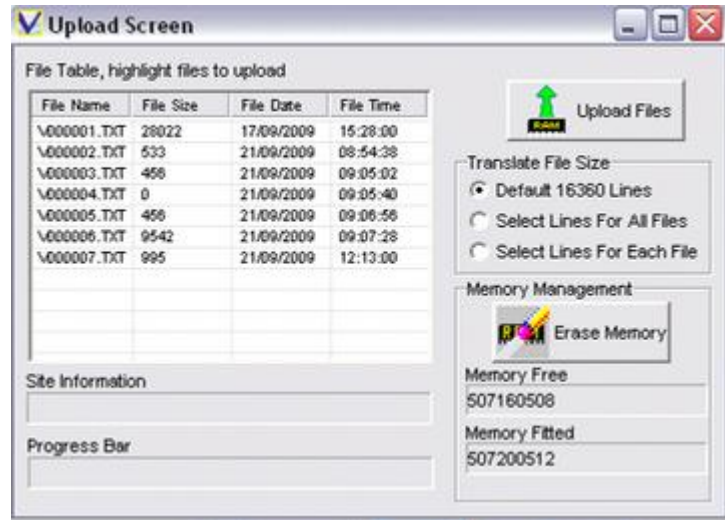

Choose the files you wish to upload by highlighting them, using the standard Windows Shift and Ctrl buttons to select multiple files. Then click the “Upload Files” button

The text files may be opened in a standard spreadsheet package for further analysis or manipulation. A confirmation window will appear to show that the process is complete.

8.3 Data Display - TideMaster Express

Simple	A numerical display (large characters) of the latest reading from any single chosen parameter.
Scroll	A tabular display listing the current and historical data from any single chosen parameter.
Graph	A time series graphical display of data from multiple parameters.
Surge Graph	A graphical representation of the difference between predicted and observed tides. (Only available if predicted files are loaded)
Last Data	A tabular display showing the latest reading from multiple parameters.
Wind Rose	A graphical representation of the current wind speed and direction.
Predicted	A graphical representation of predicted tide data

The data display functions of TideMaster Express have been designed around the concept of “create your own display”. There are six basic display window types; each may be selected from the “Display Type” menu.

8.3.1 Simple Display

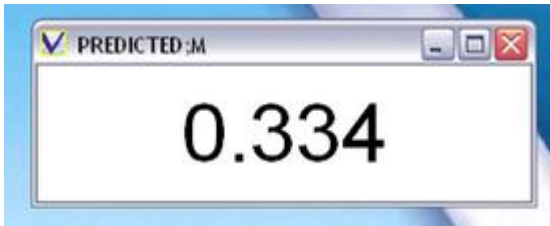

This display type gives a numerical reading of any single chosen parameter, and indicates the last value received for that parameter.

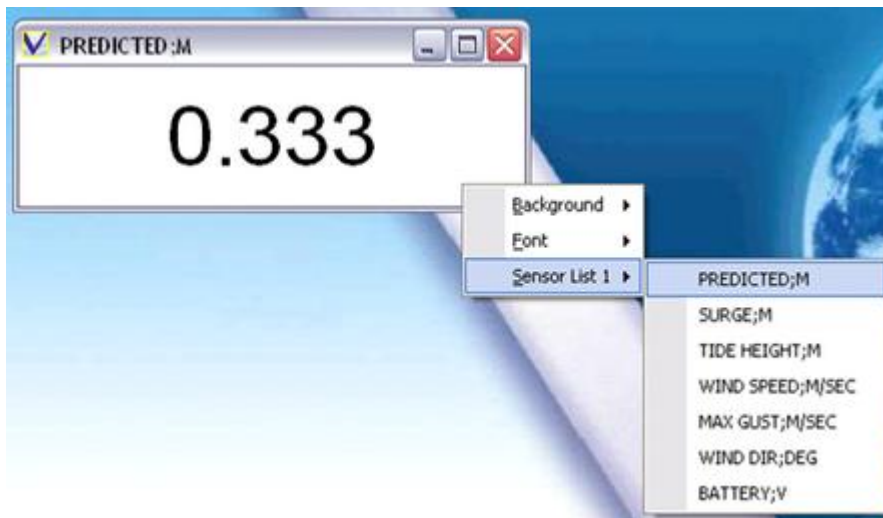

Right-click the display to show an Options menu. Simply choose the required sensor – Predicted Tide in this example.

The Simple Display will immediately indicate the last received reading for that parameter.

8.3.2 Scroll Display

Date	Time	TIDE HEIGHT;M	SD
02/12/2009	11:40:00	0.479	0.001
02/12/2009	11:39:00	0.480	0.001
02/12/2009	11:38:00	0.481	0.002
02/12/2009	11:37:00	0.483	0.002
02/12/2009	11:36:00	0.485	0.001
02/12/2009	11:35:00	0.490	0.001
02/12/2009	11:34:00	0.491	0.002
02/12/2009	11:33:00	0.495	0.002
02/12/2009	11:32:00	0.497	0.002

This display type gives a sequential list of data points from all available parameters.

When opened, the display appears as indicated, showing the date and time of each measurement, the measured value, and the Standard Deviation of the data in the measurement burst. This is a useful indication of the quality of the measurement.

Right-click the display to show an Options menu. Simply choose the required sensor and it will be added to the scroll window.

8.3.3 Graph Display

This display type shows a time series of the chosen parameter(s). Whilst it is possible to include up to 6 parameters on a single time series, it is often easier to view multiple graphs, each only showing one or two sensors.

Right-click the display to show an Options menu.

Simply choose the required sensor – Tide Height in this example. Note that repeating this process will add further sensors to the same graph. Note also that selecting “File” from the Options list will allow a graph to be quickly shown of any logged data file, without adding it the Sensor List.

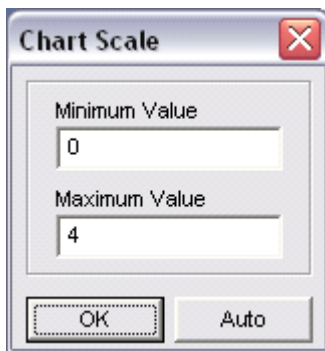
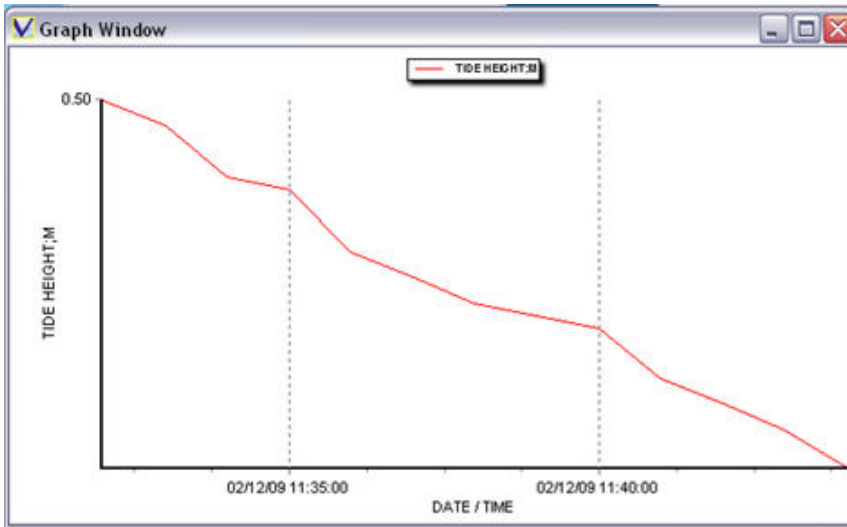

The Y axis of the graph will auto-scale for each parameter, to cover the range of data currently being displayed. The resolution of the axis labels may therefore change over time. It is possible to fix the range of each axis by right-clicking the axis. This will display this dialogue box:

Use this box to set the required maximum and minimum scale values, and click OK. Alternatively, simply click “Auto” to return to auto-scaling mode.

8.3.4 Surge Graph Display

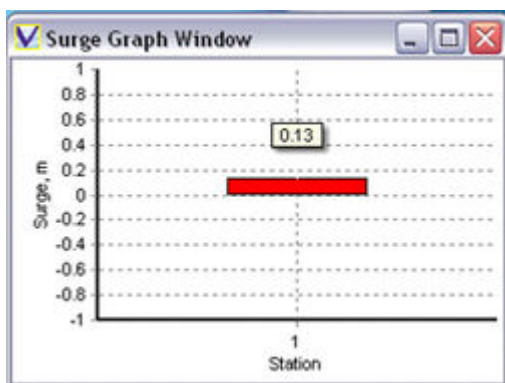

This data display mode will only work if a prediction file has been loaded into memory.

It displays a graphical representation of the difference between the observed tide and the predicted tide. See section 8.3.7 for details of how to load a prediction file.

8.3.5 Last Data Display

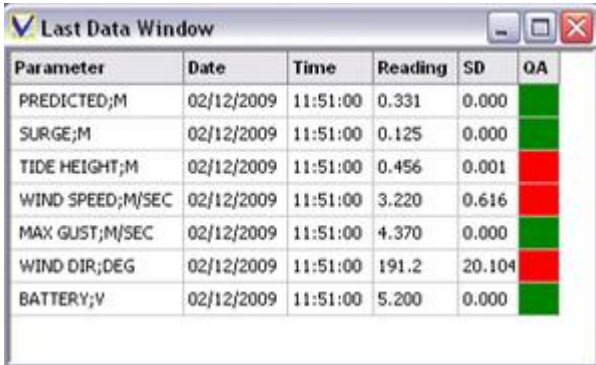

Parameter	Date	Time	Reading	SD	QA
PREDICTED;M	02/12/2009	11:51:00	0.331	0.000	Green
SURGE;M	02/12/2009	11:51:00	0.125	0.000	Green
TIDE HEIGHT;M	02/12/2009	11:51:00	0.456	0.001	Red
WIND SPEED;M/SEC	02/12/2009	11:51:00	3.220	0.616	Red
MAX GUST;M/SEC	02/12/2009	11:51:00	4.370	0.000	Green
WIND DIR;DEG	02/12/2009	11:51:00	191.2	20.104	Red
BATTERY;V	02/12/2009	11:51:00	5.200	0.000	Green

This data display mode allows the most recent reading from multiple sensors to be displayed in a tabular format.

Right-click the display to show an Options menu. Simply choose the required sensors. Note that repeating this process will add further sensors to the table.

8.3.6 Wind Rose Display

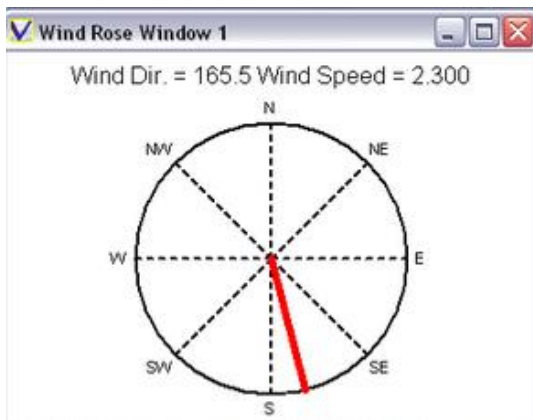

The wind rose display provides a convenient indication of the direction from which the wind is currently blowing, as well as giving a numerical indication of the magnitude and bearing.

This display will appear when “Wind Rose Display” is selected from the Display Type menu, and will be updated as new data is received.

The display may be moved and sized, but there are no other user changeable features.

8.3.7 Prediction Files

All measured tide data may be compared to predicted tide data for a designated site, provided it is available in the standard UK Hydrographic Office “.mt04” format.

The Prediction File should be placed in a convenient location either locally or the LAN – note that if it is on the LAN then multiple users may access the file

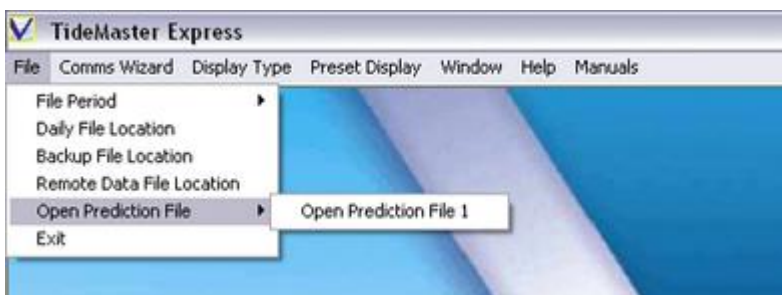

Open the File by clicking File / Open Prediction File, and navigating to the correct location. Click Open

Section 8 | Data Display in TideMaster Express

When the Prediction File is opened, TideMaster Express will perform a cubic spline fit on the hourly tidal prediction values contained in the file, to create a minute by minute tidal prediction data set.

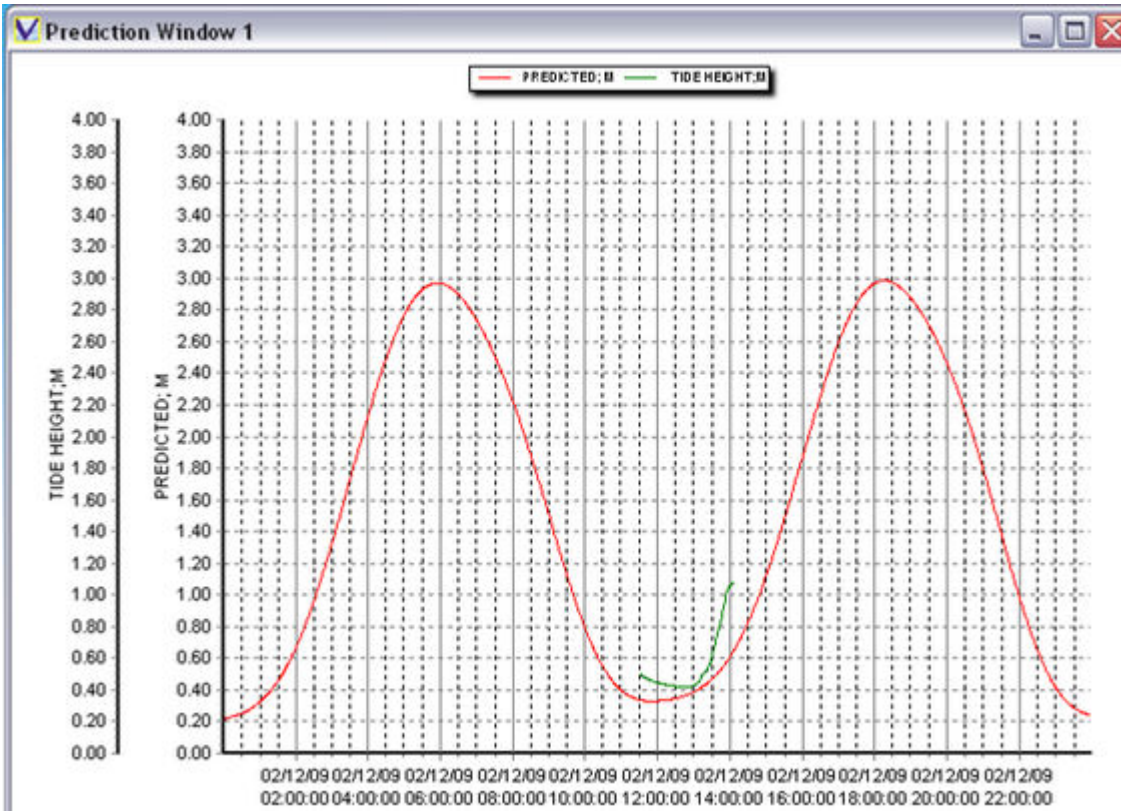

Right-clicking the display will reveal an Options menu as indicated. The first item, “Time Period”, allows the user to select the range of Prediction data that will be available for display on this graph at any time. The choice is either “Day” which will show the data for a full calendar day from midnight to midnight, or “24 Hour Band”, which shows a moving graph of data for a full 24 hour period, centred on the current time (i.e. 12 hours before and 12 hours after the current time).

Note that additional parameters may be added to this graph using the Sensor Lists as for other display modes. It is normal to restrict additional parameters on this graph to measured Tide and perhaps Surge values.

8.3.8 Preset Displays & Display Handling

When a suitable display has been created, the format may be saved to one of 6 Preset Displays. Simply click “Preset Display”, select one of the 6 “User Displays” as indicated, and Click “Save”.

To load a previously set display format, simply click “Load”.

9 Data Requests and Output Formats

Notes:

- All commands must be confirmed using “Carriage Return” or “Enter” on the keyboard, with the exception of the “Stop” command (#).
- All commands are echoed back by the instrument as they are typed

9.1 Stop Command

The instrument can be stopped when it is awake by sending the ‘#’ character.

Once interrupted the instrument returns a ‘>’, and waits for a further command. If no command is received for 5 minutes then the unit will resume operation and return to its sampling pattern.

9.2 Run Commands

M1	Performs continuous measurement at 0.5 Hz(pressure) / 10s interval (Radar)
B1	Burst sampling pattern of 30 seconds / 1 minute
B2	Burst sampling pattern of 40 seconds / 6 minutes
B3	Burst sampling pattern of 40 seconds / 10 minutes
B4	Burst sampling pattern of 40 seconds / 15 minutes
B5	Burst sampling pattern of 60 seconds / 30 minutes
#028	Resume previously set sampling rate

9.3 Logger Control

\$DIR	Outputs file table (list of data files)
\$CLR	Clears memory (use with caution!)
\$OCLK	Reads Current Date & Time
\$ICLK;DD;MM;CC;YY;HH;MM;SS	
	Sets Date & Time
	e.g.: \$ICLK;03;02;20;08;14;30;00 sets clock to 14:30:00 on 3rd February 2008
\$DEL;filename	Deletes specific file e.g.: \$DEL;File1
\$EXTT;filename	Performs simple text output data contained in specific file
\$EXTZ;filename	Performs Zmodem extraction of data contained in specific file
\$FREE	Outputs amount of free memory
\$VOLT	Reads internal battery voltage levels

9.4 Data Formats

Each time the TideMaster is interrupted and set into run mode or turned on it will create a new file. The header and output fields will depend on the sensors fitted.

Each logged file contains header information terminated with a ETX (end of transmission character). This allows the header to be easily expanded in the future.

Data is stored as Tab delimited. The logged files should be readable by MS Excel without modification.

Date/Time is stored in the format DD/MM/YYYY hh:mm:ss

9.4.1 Logged Data (Pressure Tide & Met)

Firmware version:	0741705A5
File Creation Date:	23/01/2013 14:27:23
Battery Level:	5.7
TideMaster S/N:	3
Station ID:	01
Site info:	Valeport test site!
Calibrated:	18/07/2012
Mode:	B1
Pressure units:	m
output format:	TIDEMASTER
User Pressure cal:	
Gain:	1.234000
Offset:	1.000000
Vale Pressure cal:	
P0:	-4.353197e-10
P1:	0.003194
P2:	-1.795884
Wind speed units:	Knots
Air Pressure units:	mBar
Air Temperature units:	DegC

Time Stamp [TAB] Depth [TAB] Depth SD [TAB] Wspeed [TAB] Wspeed SD [TAB] Max Gust [TAB] Wdir [TAB] Wdir SD [TAB] Air Pressure [TAB] Air Pressure SD [TAB] Air Temperature [TAB] Air Temperature SD [TAB] Dewpoint [TAB] Dewpoint SD [TAB] Humidity [TAB] Humidity SD [TAB] Batt Status.

When interfaced to a Gill MaxiMet instrument the wind direction reported is corrected.

The Max Gust is the maximum wind speed observed during the burst period (see section [6.3.2](#))

9.4.2 Logged Data (Pressure Tide & CT)

Firmware version:	0741705A5 miniCT
File Creation Date:	23/01/2013 14:30:56
Battery Level:	5.7
TideMaster S/N:	3
Station ID:	01
Site info:	Valeport test site!
Calibrated:	18/07/2012
Mode:	B1
Pressure units:	m
output format:	TIDEMASTER
User Pressure cal:	
Gain:	1.234000
Offset:	1.000000
Vale Pressure cal:	
P0:	-4.353197e-10
P1:	0.003194
P2:	-1.795884
Water Temperature units:	DegC
Water Conductivity units:	mS

Time Stamp [TAB] Depth [TAB] Depth SD [TAB] WaterTemp [TAB] WaterCond [TAB] Batt Status

9.4.3 Logged Data (Radar Tide and Met)

Firmware version:	0741705A5
File Creation Date:	23/01/2013 10:28:01
Battery Level:	9.1
TideMaster S/N:	3
Station ID:	01
Site info:	Valeport test site!
Calibrated:	18/07/2012
Mode:	B1
Pressure units:	m
output format:	TIDEMASTER
Radar:	
Min limit:	0.500
Max Limit:	2.000
Datum:	2.000
Pre ample:	4
Wind speed units:	Knots
Air Pressure units:	mBar
Air Temperature units:	° C

Time stamp [TAB] Depth [TAB] Depth SD [TAB] Wspeed [TAB] Wspeed SD [TAB] Max Gust [TAB] Wdir [TAB] Wdir SD [TAB] Air Pressure [TAB] Air Pressure SD [TAB] Air Temperature [TAB] Air Temperature SD [TAB] Dewpoint [TAB] Dew point SD [TAB] Humidity [TAB] Humidity SD [TAB] Batt Status

The Max Gust is the maximum wind speed observed during the burst period (see section [6.3.2](#))

9.4.4 Logged data (Radar Tide and CT)

Firmware version:	0741705A5 miniCT
File Creation Date:	23/01/2013 14:33:36
Battery Level:	5.7
TideMaster S/N:	3
Station ID:	01
Site info:	Valeport test site!
Calibrated:	18/07/2012
Mode:	B1
Pressure units:	m
output format:	TIDEMASTER
Radar:	
Min limit:	0.500
Max Limit:	20.000
Datum:	2.000
Pre amble:	4
Water Temperature units:	Deg C
Water Conductivity units:	mS

Timestamp [TAB] Depth [TAB] Depth SD [TAB] WaterTemp [TAB] WaterCond [TAB] Batt Status

9.4.5 Real Time Data

Real Time data can be broadcast in several different formats.

9.4.5.1 NMEA

A NMEA style output is the standard data format and provides the most detailed information from the instrument. The TideMaster will always output the \$PVTM0 string and will additionally output a \$PVTM1 or \$PVTM2 string if an additional sensor is enabled.

\$PVTM0 = Tide data, same for Pressure or Radar measurement

\$PVTM0,ID,ddmmyyyy,hhmmss,tt.ttt,h.hhh,D,vv.v,SSSS*hhCL (52 chars)

// ID	Station ID
// Date	ddmmyyyy
// Time	hhmmss
// Tide Height	tt.ttt
// Tide height stdev	h.hhh
// Tide height units	D (0,1,2) (dBar, Metres, Feet)
// Battery voltage	vv.v
// Status	
// *hh checksum of the above	
// CL <cr><lf>	end of string

\$PVTM1 = Meteorological Data, same format for Windsonic or MetPak II

\$PVTM1,ID,ddmmyyyy,hhmmss,sss.ss,kk.kk,mmm.mm,S,ddd.d,nn.nn,aaaa.a,A,ttt.t,T,ppp.p,hhh.h*hhCL (85 chars)

// ID	Station ID
// Date	ddmmyyyy
// Time	hhmmss
// wind speed	sss.ss
// wind speed	stdev kk.kk
// max gust	mmm.mm
// wind speed units	S (0,1 or 2) (kts, m/sec, mph)
// wind direction	ddd.d
// wind direction	stdev nn.nn
// air pressure	aaaa.a
// air pressure units	A (0,1) (hPa mbar)
// air temperature	ttt.t
// temperature units	T (0 or 1) (degC DegF)
// dew point	ppp.p
// humidity	hhh.h
// *hh	checksum
// CL <cr><lf>	end of string

\$PVTM2,ID,ddmmyyy,hhmmss,tt.ttt,T,CC.CCC,mS,*hhCL

//Water Temperature	tt.ttt
//Water Temperature Units	T (0=Deg C, 1=DegF)
//Water Conductivity	CC.CCC
//Water Conductivity units	mS– always mS
//*hh checksum	
// CL <cr><lf> end of string	

9.4.5.2 740 Multi-Gauge

ID:01 TIME:20/11/2009 09:29:00 P(dBar)= 3.487 D(m)= 3.152<CR><LF>
 ID:01 TIME:20/11/2009 09:29:00 P(dBar)= 3.478 D(m)= 3.142<CR><LF>
 ID:01 TIME:20/11/2009 09:30:00 P(dBar)= 3.472 D(m)= 3.136<CR><LF>

Where:

ID:01: Station ID(1-10)
 TIME:20/11/2009 09:28:00: Time/Date DD/MM/YYYY hh:mm:ss
 P(dBar)= 3.487: Tide Height in Decibars
 D(m)= 3.152: Tide Height in Metres

- Space and Tab delimited:

ID:01 <TAB>TIME:20/11/2009<SPACE>09:29:00<TAB>P(dBar)=<SPACE>3.487
 D(m)=<SPACE>3.152<CR><LF>

- Fixed length
- Terminated with Carriage return and Line Feed characters

9.4.5.3 740a

A shortened form of the 740 telegram

DBar

P(dBar)= ddd.ddd<CR><LF>

Metres

P(dBar)= ppp.ppp D(m)= mmm.mmm<CR><LF>

Feet

P(dBar)= ppp.ppp D(ft)= fff.fff<CR><LF>

Where:

P(dBar)= 3.487 Tide Height in dBar
 D(m)= 3.152: Tide Height in Metre
 D(ft)= 10.341 Tide Height in Feet

10 Wiring Information

Wiring colours are correct at the time the manual was printed. However, it is advised that continuity checks are performed prior to all terminations.

10.1 Tide (Pressure)

END 1: Pressure Sensor	END 2: 6Way Connector UTS6JC10E6P		PRESSURE
	CONNECTOR	PIN	
Druck PDCR1830	6 Way Modified UTS - UTS6JC10E6P	A	V+
		B	GND
		C	SIG+
		D	SIG-
		E	N/C
		F	Screen

10.2 Tide (VRS-20 Radar) - Discontinued

END 1: 0745518 PCB Into Radar Junction Box		END 2: 0745518 PCB Out of Radar Junction Box		END 3: UTS6JC10E7S TideMaster	END 4: D - Type (for setup)	FUNCTION
PIN	BOARD	PIN	PIN	PIN		
1						POWER_GND
2						POWER_IN
3						RS232_OUT OF RADAR
4						RS232_IN TO RADAR
5						RS232_GND
6						SCREEN
	J3 6Way Terminal block (Stripped & twisted end)	1	B			POWER_GND
		2	A			POWER_IN
		3	D			RS232_OUT OF RADAR
		4	C			RS232_IN TO RADAR
		5	E			RS232_GND
		6	E			SCREEN
					2	RS232_OUT OF RADAR
					3	RS232_IN TO RADAR
					1,5,6,8,9	RS232_GND
					SHELL	SCREEN

10.3 WindSONIC

END 1: GILL Sensor		END 2: 6Way UTS - UTS6JC10E6P		FUNCTION
CONNECTOR	PIN	CONNECTOR	PIN	
Windsonic 9 way connector as supplied with Windsonic Sensor	3	6 WAY UTS - UTS6JC10E6P	A	V+
	2		B	GND
	7		C	RS232 Out to Gill
	5		D	RS232 In from Gill
	1		E	Gill 232 Gnd
			F	Screen

10.4 METPAK II

END 1: GILL MetPak II		END 2: 6Way UTS -UTS6JC10E6P		FUNCTION
CONNECTOR	PIN	CONNECTOR	PIN	
J5 8 way Push fit Block Pin 1 is nearest edge of board adjacent to earth post.	8	6 WAY UTS - UTS6JC10E6P	A	V+ Supply to Gill
	7		B	GND Supply to Gill
	4		C	RS232 Out to Gill
	3		D	RS232 In from Gill
	2		E	Gill 232 Gnd
			F	Screen

10.5 MaxiMet

Available from firmware version 0741705B9

END 1: GILL MaxiMet Sensor		END 2: 6Way UTS -UTS6JC10E6P		FUNCTION
CONNECTOR	PIN	CONNECTOR	PIN	
MaxiMet 9 way connector as supplied with MaxiMet Sensor	2	6 WAY UTS - UTS6JC10E6P	A	V+ Supply to Gill
	3		B	GND Supply to Gill
	7		C	RS232 Out to Gill
	5		D	RS232 In from Gill
	1		E	Gill 232 Gnd
			F	Screen

Only to be used with Gill MaxiMet sensor

10.6 miniCT

END 1: MiniCT Sensor		END 2: 6Way UTS -UTS6JC10E6P		FUNCTION
CONNECTOR	PIN	CONNECTOR	PIN	
6 WAY MALE LINE CONNECTOR MCIL6M	4	6 WAY UTS - UTS6JC10E6P	A	V+ Supply to MiniCT
	6		B	GND Supply to MiniCT
	3		C	RS232 Out to MiniCT
	2		D	RS232 In from MiniCT
	1		E	MiniCT 232 Gnd
			F	Screen

10.7 3m Y Lead (RS232)

END 1: 7 Way UTS Connector (red ring)		END 2: 9 WAY D-TYPE		END 3: BANANA PLUGS	FUNCTION
CONNECTOR	PIN	CONNECTOR	PIN	CONNECTOR	
7 Way NC7CF10	E	9WAY D-SOCKET WITH HOOD	1,5,6,8,9		RS232_GND
	D		3		RS232_IN
	C		2		RS232_OUT
	E		Connect Screen to Shell		SCREEN
	A			Red 4mm Banana plug	POWER_IN
	B			Black 4mm Banana plug	POWER_GND
	F				COMMS_SEL
	G				RADIO_ON

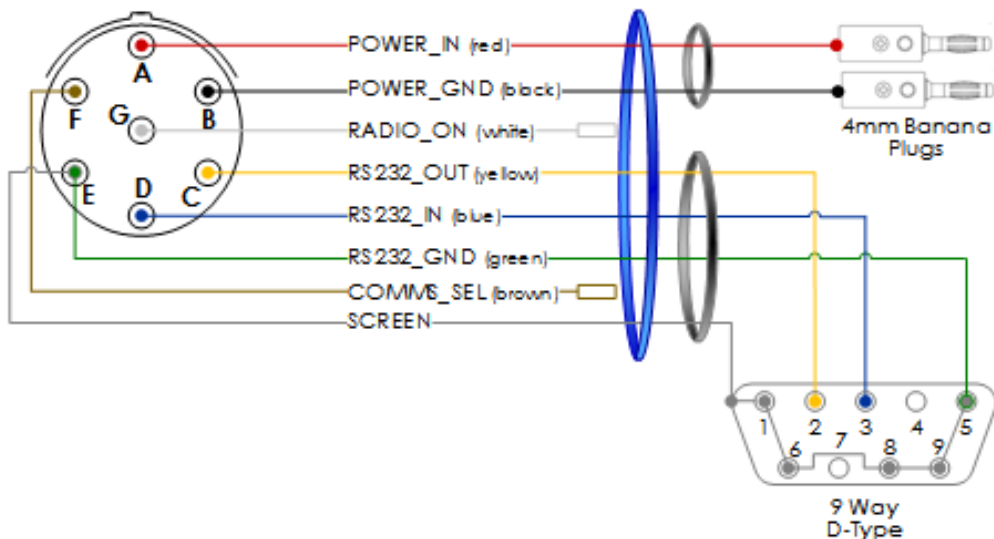

11 Declaration of Conformity - TideMaster

Please note: Any changes or modifications to the product or accessories supplied, that are not authorised by Valeport Ltd, could void the CE compliance of the product and negate your authority to operate it. This product has demonstrated CE compliance under conditions that include the use of shielded cables. It is important that you use shielded cables compliant with the product's conformance, to protect from potential damage and reduce the possibility of interference to other electronic devices.

11.1 UKCA Certificate



UK Declaration of Conformity

Manufacturer:	Valeport Ltd
Address:	St Peter's Quay, Totnes, Devon, TQ9 5EW
Certification marking:	UKCA
Product Description:	TideMaster

We the manufacturer declare that the product **TideMaster** is in conformity with the following UK Statutory requirements and designated standard(s):

Radio Equipment Regulations 2017	Standards
Safety (SI 2016 No.1101)	BS EN 61010-1:2010 BS EN 62479:2010 BS EN 60950-1:2006+A2:2013
EMC (SI 2016 No.1091)	BS EN 301 489-1 V2.1.1 (Basic Level) BS EN 301 489-17 V3.1.1 BS EN 60945:2002 BS EN 61326-1:2013 (Basic Level)
Radio Spectrum (SI 2017 No. 1206)	BS EN 300 328 V2.1.1 BS EN 300 330 V2.1.1 BS EN 303 413 V1.1.1





ROHS Regulations 2012	Standards
SI 2012 No. 3032	BS EN IEC 63000:2018

Name:	D.Lakin
Position:	Development Engineer
Place of issue:	Valeport Ltd, Totnes, UK
Date of issue:	14 January 2020
Signature:	

Valeport Limited
St. Peter's Quay, Totnes,
Devon TQ9 5EW UK

+44 (0) 1803 869292
sales@valeport.co.uk
www.valeport.co.uk

VAT No GB 365 8763 67
Registered in England No 1950444

11.2 EU CE Certificate



EU Declaration of Conformity

Manufacturer:	Valeport Ltd
Address:	St Peter's Quay, Totnes, Devon, TQ9 5EW
Certification marking:	CE
Product Description:	TideMaster

We the manufacturer declare that the product TideMaster, is in conformity with the following EU Directives and harmonised standard(s):

Radio Equipment Directive 2014/53/EU	Standards
Safety (Article 3.1a)	BS EN 61010-1:2010
EMC (Article 3.1b)	EN 301 489-1 V2.1.1 (Basic Level) BS EN 61326-1:2013 (Basic Level)
Radio Spectrum (Article 3.2)	<Manufacturer standard>

RoHS Directive 2015/863/EU	Standards
Prevention (Article 4.1)	BS EN IEC 63000:2018

Name:	D.Lakin
Position:	Development Engineer
Place of issue:	Valeport Ltd, Totnes, UK
Date of issue:	14 January 2020
Signature:	

Valeport Limited
 St. Peter's Quay, Totnes,
 Devon TQ9 5EW UK

+44 (0) 1803 869292
 sales@valeport.co.uk
www.valeport.co.uk

VAT No. GB 165 8753 67
 Registered in England No. 1950444

